



Track system

To get you right back on track and based on our customers' feedback, we have developed the NL Power Track System which will work with our track lights to ensure compatibility with both previous and future systems.



NLP 3-Circuit track system, standard

Technical Specification

NLP 3-Circuit track system. Termoplastic connectors in white, black or grey. Metal accessories also in white, black, or grey. Tracks supplied in papercover. Copper-leads nickle-plated for maximum protection against oxidization of leads. Knockout holes in track for direct to surface installation or via different ceiling brackets. Appovedby SEMKO with CB-certificate.

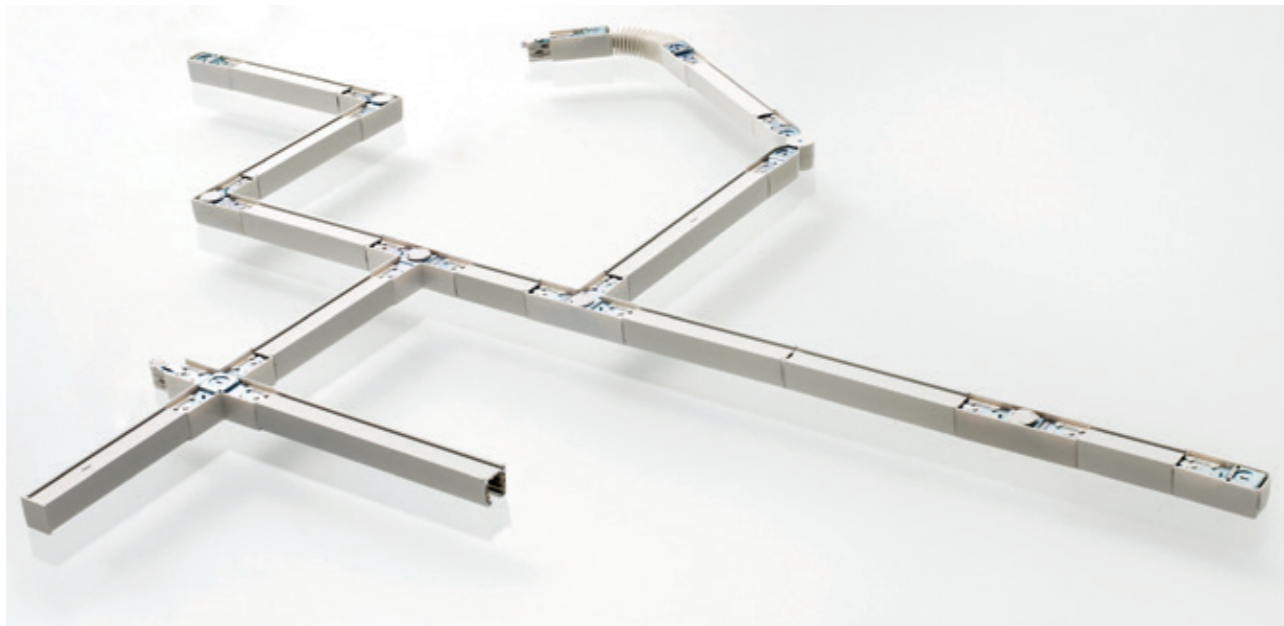

NLP 3-Circuit track system, standard

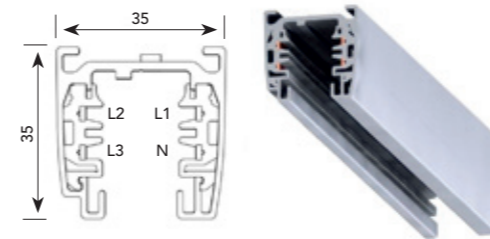

Track

047-25	1 000 mm	047-258	2 390 mm
047-358	1 610 mm	047-27	3 000 mm
047-26	2 000 mm	047-28	4 000 mm

General info.

Protection IP20
16 A /400 V
Parts marked with * are feedable.

Standard colors, -XX

10 White, RAL 9010
20 Black, Sample plates available
30 Grey, Sample plates available

047-11 End Cover	047-201 X Connector	047-202/047-302 T-Connector, Left*/Reverse*
047-203/047-303 T-Connector, Right*/Reverse*	047-204/047-304 L-Connector*/Reverse*	047-205 Middle Connector*
047-206 End feed, Left*	047-207 End feed, Right*	047-264 Flex 60 Connector*
047-209 Mini-Connector	047-255 Flexible Connector	



NLP 3-Circuit track system, standard

Suspension Parts

Suspending a track can be done in two ways with wire or rod.

Acoustic ceiling Parts

These parts are used for installing the track system into a architect ceiling.

Others

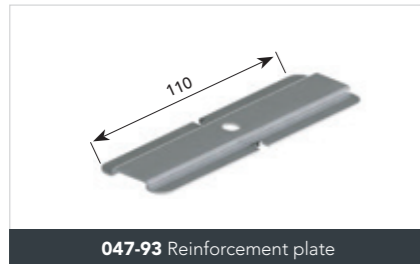

047-93 Reinforcement plate

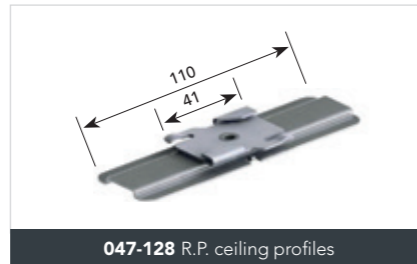

047-128 R.P. ceiling profiles



047-210 Suspension hook

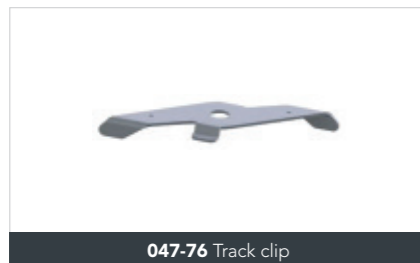

047-76 Track clip

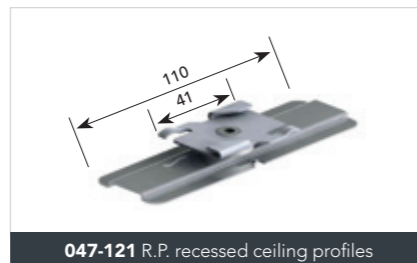

047-121 R.P. recessed ceiling profiles

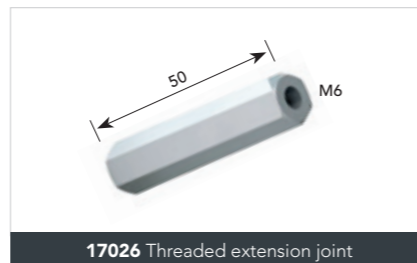

17026 Threaded extension joint



047-181 R.P. for Wire suspension



047-19 Track clip ceiling profiles

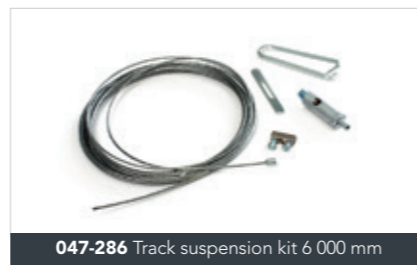

047-286 Track suspension kit 6 000 mm

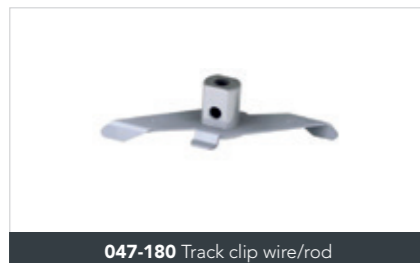

047-180 Track clip wire/rod



047-100 Track clip recessed ceiling profiles



047-283 Rod to fixate track

NLP 3-Circuit track system, recessed

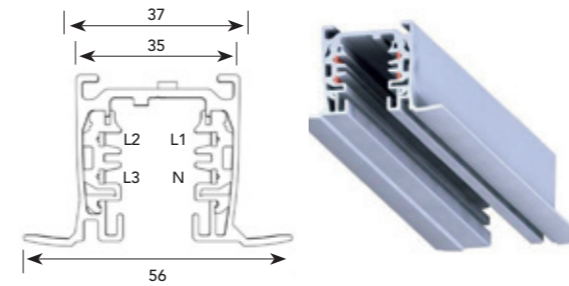

Track

047-39	1 000 mm	047-268	2 390 mm
047-368	1 610 mm	047-37	3 000 mm
047-38	2 000 mm	047-36	4 000 mm

General info.

Protection IP20
16 A /400 V
Parts marked with * are feedable.

Standard colors, -XX

10 White, RAL 9010
20 Black, Sample plates available
30 Grey, Sample plates available

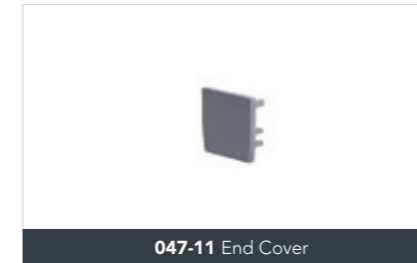

047-11 End Cover

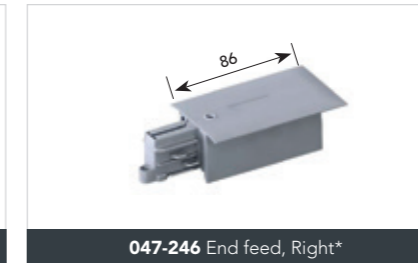

047-246 End feed, Right*

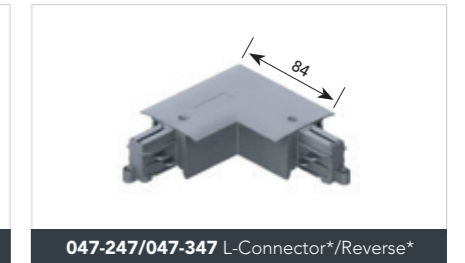

047-247/047-347 L-Connector*/Reverse*



047-248/047-348 T-Connector, Left*/Reverse*

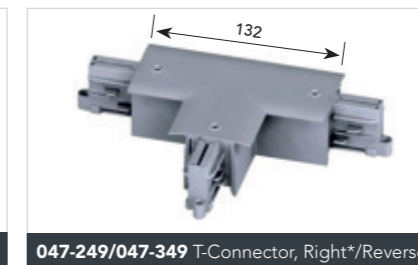

047-249/047-349 T-Connector, Right*/Reverse*



047-250 X-Connector

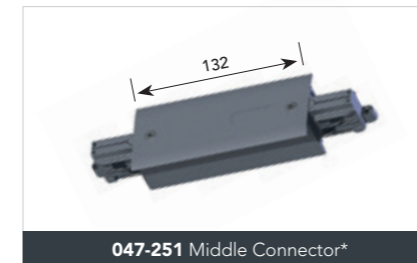

047-251 Middle Connector*



047-209 Mini-Connector



047-245 End feed, Left*



NLP 3-Circuit track system, good to know

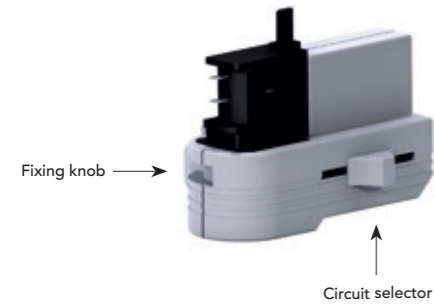

3-Circuit Adapter. New version, rotatable 360°

The adapter is factory installed on the track fixtures. It is used to connect the fixture to the NLP 3-circuit track system. The adapter also suits the majority of other 3-circuit track systems. Check with Nordic Light. Track adapter is not sold separately.

Installation:

1. Push the adapter into the track
2. Turn the fixing knob clockwise
3. Select the desired phase on the circuit selector switch.

To remove the adapter from the track reverse the installation steps.

Ratings:

3 A, 220-240 V
IP 20
Max load: 50 N

NLP 3-Circuit track system, good to know

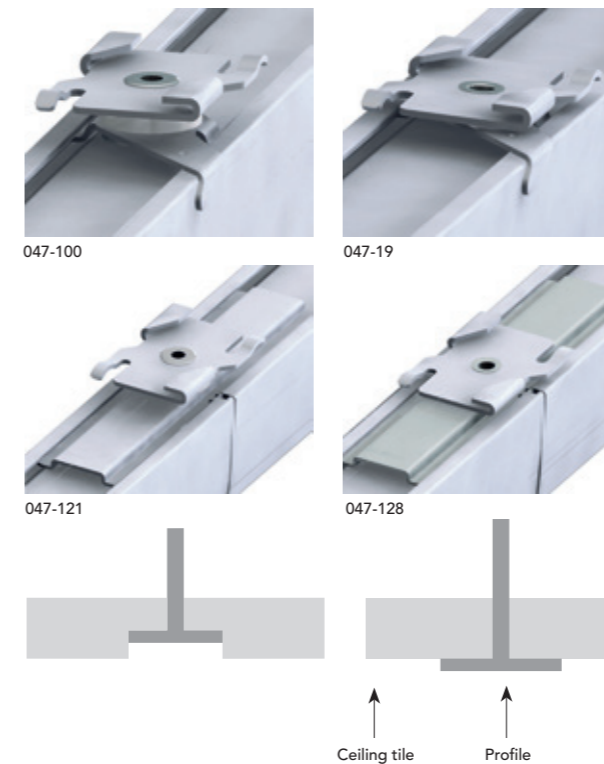

Acoustic ceiling parts

These parts are used for installing the track system into a acoustic ceiling. There are two main types of acoustic ceilings, one with recessed profile (1) and one non recessed (2), choose mounting accessories according to ceiling type.

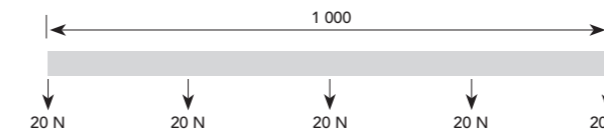

Load and fastening

Maximum distance allowed between each fastening point is 2 m. The maximum load on the track is 10 kg.

For 1 m track the maximum load is thus 10 kg.

The tracks have knockout holes on the top side. These can be used for direct mounting into the ceiling with screws.

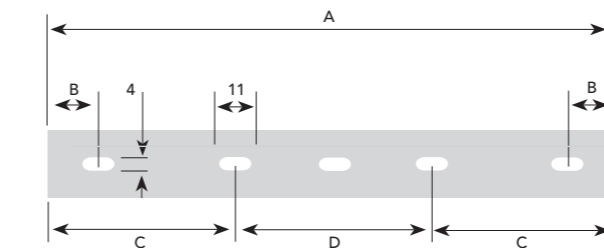

A (mm)	B (mm)	C (mm)	D (mm)
4 000	152	1 195	1 603
2 390	152	1 195	-
1 610	152	-	-

Monopoint

The monopoint is used for installing a track light without a track. The monopoint can be used in combination with the 3-Circuit adapter.

- 27009 Monopoint, White
- 27010 Monopoint, Black
- 27011 Monopoint, Grey
- 047-320-10 Recessed holder, White
- 047-320-20 Recessed holder, Black
- 047-320-30 Recessed holder, Grey

Ratings:

3 A, 220-240 V
IP 20
Max load: 50 N



Suspension Parts

Suspending a track can be done in two ways with wire or rod. Use 047-180 or 047-181 for this type of suspension.

Wire: Thread the wire through the hole in the track clip and band it back up through the wire lock. Secure the wire with the screws.

Rod: Thread the rod into the 047-181, the rod should have M6 threads. **Screw:** 047-76 or 047-93 can be used to fasten the track directly into the framework with a screw.

To stabilize track on wire from tilting, use rod for wire suspension track system to fixate the track 047-283.

Wire suspension type MaseTek to suspend fixed loads such as track systems.





NLP 3-Circuit track system, good to know

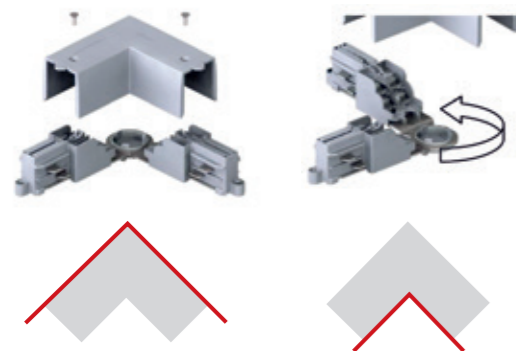

To change the L connector neutral side.

1. At first the connector has the neutral on the inside or outside
To change to the other side unscrew the two screws and remove the cover.
2. Turn one the connecting sides 180 degrees and assemble the cover. Now the connector is reverse.

T Connectors can also be changed in the same manner.

The track system seen from above.

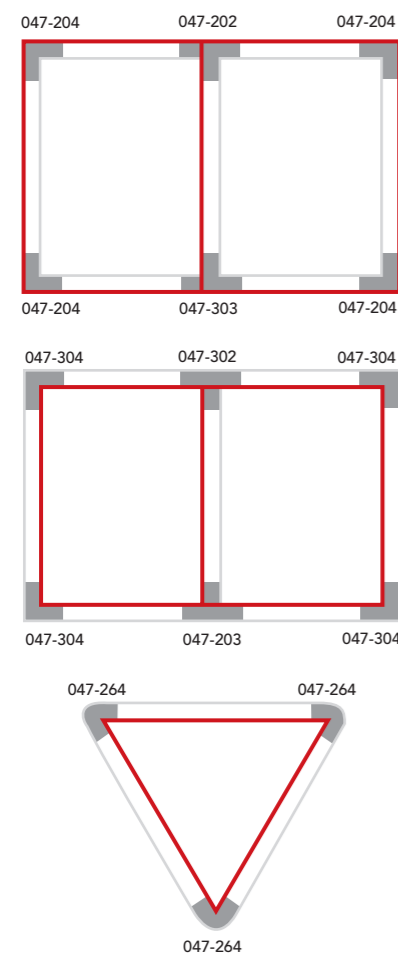

General comments on planning track systems.

1. Never supply the power to the track at several locations.
2. Make sure that the track is straight both horizontal and vertical before powering on.

The red line indicates the neutral position.

NLP 3-Circuit track system, examples



Straight track, suspended

Articles		Qty
047-28	Track 4 000 mm	2
047-206	End feed	1
047-209	Mini connector	1
047-11	End Cover	1
047-273	Track suspension	7
047-181	RF plate for wire/rod	1
047-180	Track clip for wire/rod	6

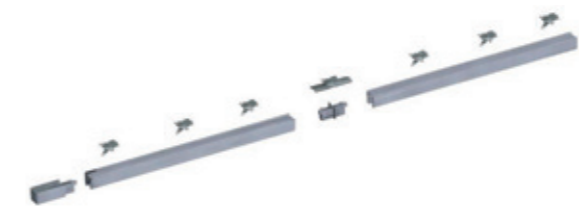

Straight track, Acoustic ceiling

Articles		Qty
047-28	Track 4 000 mm	2
047-206	End feed	1
047-209	Mini connector	1
047-11	End Cover	1
047-128	RF plate ceiling profiles	1
047-180	Track clip ceiling profiles	6



Straight track, Recessed

Articles		Qty
047-36	Track 4 000 mm	2
047-245	End feed	1
047-209	Mini connector	1
047-11	End Cover	1

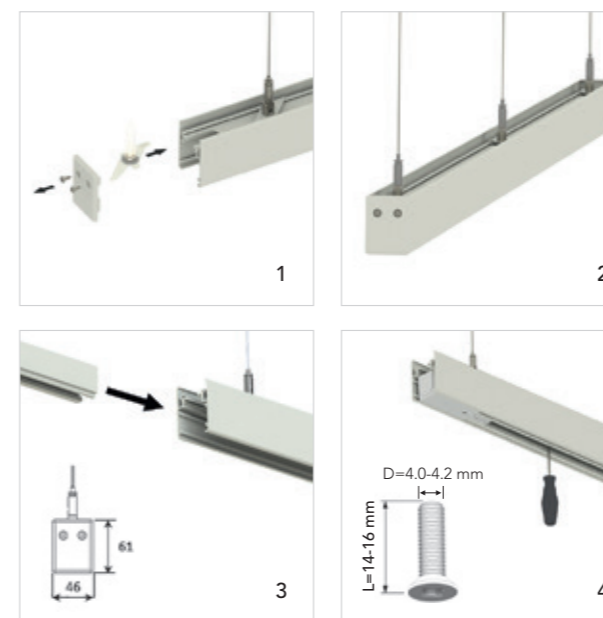

Track casing

047-500 Track 2 390 mm

Long track casing used for covering of the Nordic Light standard tracks.

1. Use the wire suspension kits enclosed. Remove the end cover from the track casing. Slide in the suspensions from the end of the Track casing.
2. Use 3 suspension points per Track section (2 390 mm) Important: The maximum load on each suspension is 20 kg. Do not exceed this load at any time.
3. The track casing is only for use with Nordic Light 3 circuit power track Type 047-***. Slide the power track into the Track casing from the end of the track casing. ATTENTION: The power track and the track casing are asymmetric. Check that the holes in the power track and the screw tower channel in the track casing is located in line with each other. If not, turn the power track the opposite way.
4. Screw the power track to the Track casing using one screw in every knock out hole in top of the power track. Use only screw of type M4 or ISO 7050, with Diameter 4.0-4.2 mm and the length 14-16 mm.